



Inverted Research Microscope

ECLIPSE

TE2000

CFI60

Taking inverted microscopy to peaks of perfection

The TE2000 redefines research with inverted microscopes. Compatible with all advanced live-cell applications, this leading-edge research station provides the highest level of optical imaging to suit today's competitive research scene.

Extendible configuration

p. 4

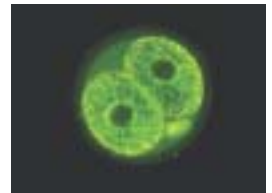

1. JC1 stained (Mitochondrial membrane potential) Murine 2 cell embryo, In-vivo derived

Epi-fluorescence images with high contrast
High performance DIC prisms

p. 6

CFI60 optical system

p. 7

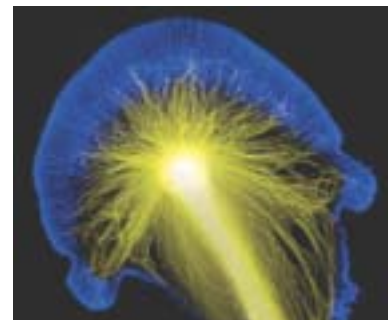

2. Aplysia bag cell neuron

Multiport design
Enhanced overall rigidity

p. 8

User-friendly ergonomic design

p. 9

Retrofittable motorized options

p. 10

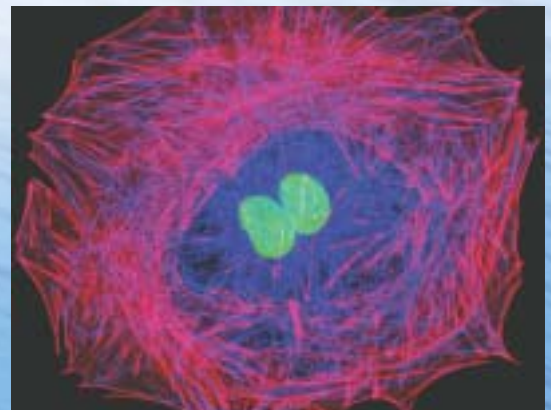

3. Albino Swiss mouse embryo fibroblast cell

TE2000-U

The TE2000-U is a universal model that comes standard with four output ports.



TE2000-S

The TE2000-S, a basic model that can be dedicated to specific tasks, comes with two output ports.

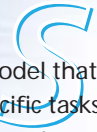

To meet research needs of all kinds, the TE2000 is available in three versions.

TE2000-E

The TE2000-E incorporates a high-precision motorized focus and vibration-free motorized optical-path changeover mechanism that facilitates image capture in 3D. The TE2000-E comes with five output ports.



Extendible configuration

Flexible extendibility facilitates the most sophisticated research

Nikon's "stratum structure" enables flexible extendibility

Taking advantage of infinity optics, the TE2000's stratum structure enables the extension of the distance between the microscope body and objectives by up to 80mm (max.).

This design allows the introduction of equipment such as laser tweezers or extra illumination into the optical path without modifying the microscope body as well as a variety of Nikon's fluorescence illumination accessories.

Nikon's "stratum structure" can efficiently provide a perfect system for your desired application. Multimode imaging capability is realized with a single microscope.

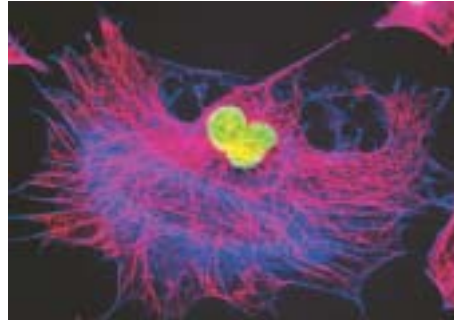

4.



Optional stage risers (70mm) allow the mounting of other equipment such as laser tweezers or a laser unit in addition to an epi-fluorescent attachment without modifying the microscope body.

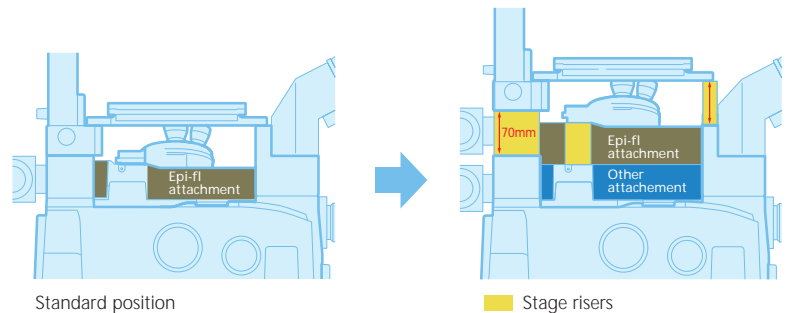
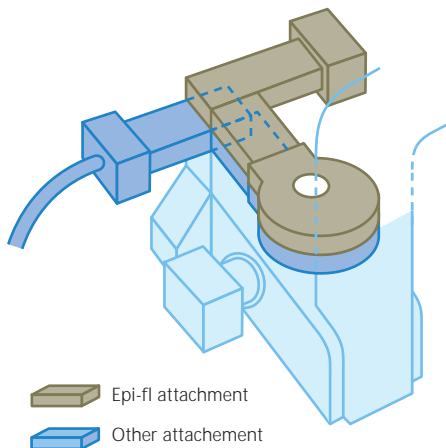

Multimode imaging as shown below is possible.

C1 (confocal laser scanning microscope)
 +
 TIRF (Total Internal Reflection Fluorescence)/epi-fluorescence system
 +
 Laser tweezers

The C1 confocal microscope can be paired with a combination of epi-fluorescence and TIRF units. The C1 and TIRF unit share one laser light source, and allow you to observe TIRF and confocal images of the same specimen with one microscope. Utilizing the stratum structure, it is possible to add laser tweezers in another stratum and provide simultaneous observation with either TIRF, C1 or epi-fluorescence illumination.

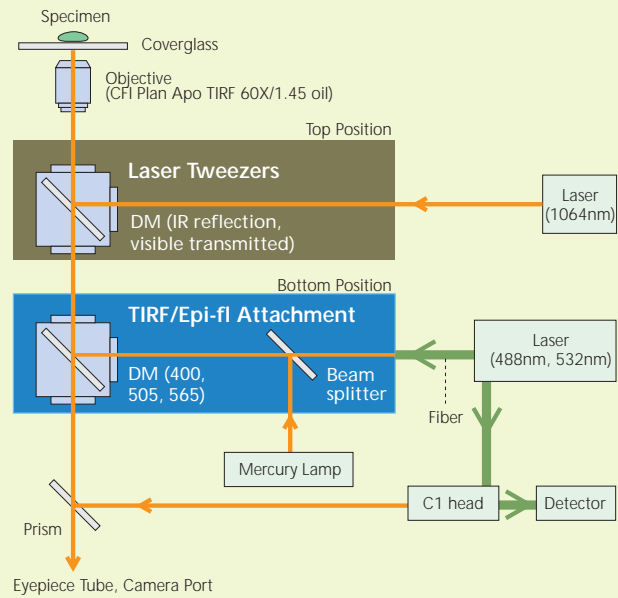

Epi-fl illumination
 +
 Near-IR-DIC attachment/FRET system
 +
 CCTV camera

Utilizing the stratum structure, it is possible to mount an epi-fl illumination system and a near-infrared DIC attachment. The image can be observed under epi-fl illumination simultaneously with viewing of dynamics of living cells with near-IR DIC illumination as the image can be divided into two wavelengths by a dichroic mirror inside the filter turret of the near-IR DIC attachment. In addition, FRET images can be captured with a spectrophotometer attachment. Furthermore, simultaneous photometry of multiple fluorescence wavelengths with multi-photon excitation is possible.

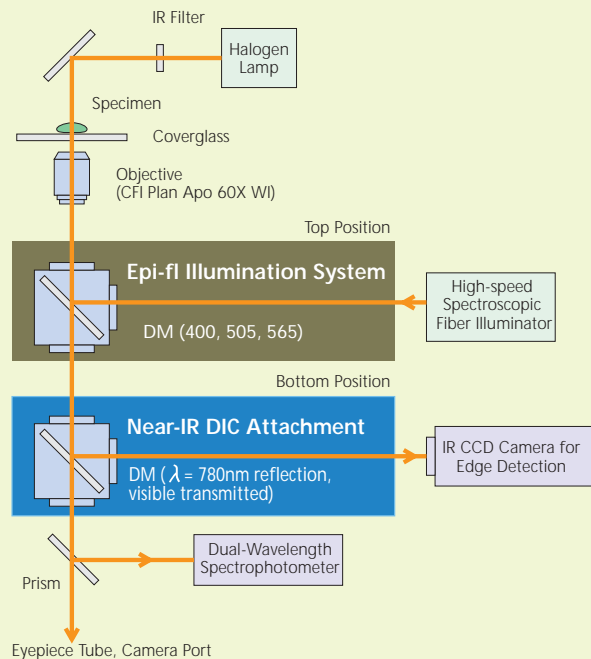

Epi-fluorescence images with high contrast

Noise Terminator mechanism

Responding to an increasing demand for fluorescence observation of higher S/N ratio images, Nikon created a new mechanism, Noise Terminator. The TE2000 incorporates this mechanism in the fluorescence illuminator and filter cubes to totally absorb stray light in the optical path. This significantly reduces noise and dramatically increases fluorescence image contrast.

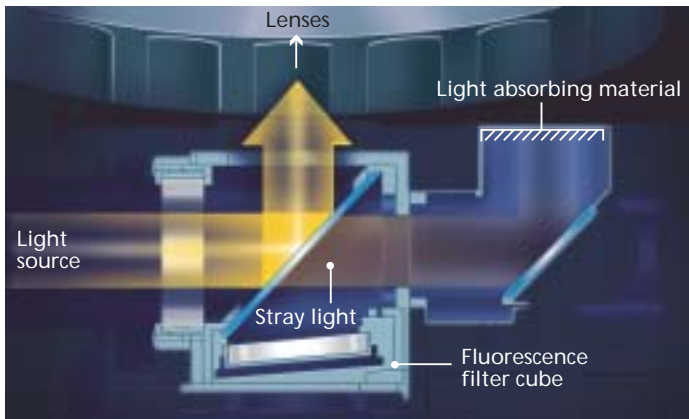

Nikon's two process mechanism first removes stray light from the filter cube completely, then absorbs it through the light absorbing material. Therefore stray light is eliminated thoroughly.

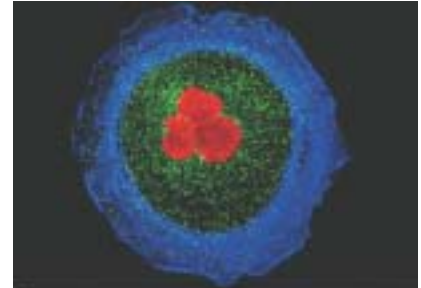

5.

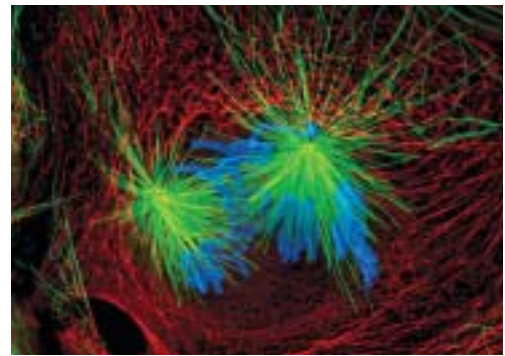

6. Neut lung cells in culture

New High Quality Fluorescence Filters

Each filter/mirror incorporated in these filters has a very sharp rising edge at the corresponding wavelength. By minimizing the crossover of each signal, Nikon succeeded in significantly reducing the loss of excitation wavelength. As a result these filters can provide high quality epi-fluorescence images. There are three types of filters: CFP, GFP, and YFP.

High performance DIC prisms

The best balance of high contrast and high resolution

By changing the material structure, Nikon succeeded in significantly improving the functionality of the standard combination of DIC modules and sliders.

The excellent balance of contrast and resolution produces high quality DIC images with no color blur at any magnification. Depending upon the type of specimen, either a high-contrast or high-resolution combination is selectable.

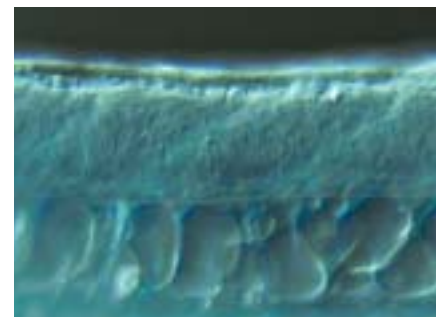

Clear, aberration-free images at any magnification

The TE2000 adopts CFI60 infinity optics, known for crisp and clear images at any magnification, while providing higher N.A.'s and longer working distances. As the focal length of the tube lens is as long as 200mm, there will be no aberration even when you introduce a phase ring, DIC prism or dichroic mirror into the optical path.



New Series of Objectives Created with Nikon's Accumulated Optical Technologies

CFI Plan Apochromat VC Series



CFI Plan Apochromat VC 60X Oil, N.A. 1.40
CFI Plan Apochromat VC 60X WI, N.A. 1.20
CFI Plan Apochromat VC 100X WI, N.A. 1.40

- Chromatic aberrations have been thoroughly corrected throughout the view field. Suitable for digital imaging.
- Perfect choice for multi-stained, fluorescence specimens and when using brightfield and DIC techniques.
- Axial chromatic aberration has been corrected up to the violet range (405nm), making these objectives highly effective for confocal applications.
- Excellent brightness throughout the view field.
- The 60X water-immersion type, in particular, features high spectral transmittance, even in the 360nm wavelength range.

CFI Plan Apochromat TIRF Series



CFI Plan Apochromat TIRF 60X Oil, N.A. 1.45
CFI Plan Apochromat TIRF 100X Oil, N.A. 1.45

- Highest N.A. of all Nikon objectives and specifically developed for TIRF applications. Can be used with a regular coverglass and immersion oil.
- A world-first temperature-change correction ring is included in the 60X oil objective. Users can easily counteract influence to the image quality from temperature-induced changes—from 23°C (room temperature) to 37°C (physical temperature)—in the refractive index of the immersion oil.
- The correction ring works perfectly in both DIC and epi-fluorescence microscopy of minute structures. It is also suitable for the laser tweezer method.

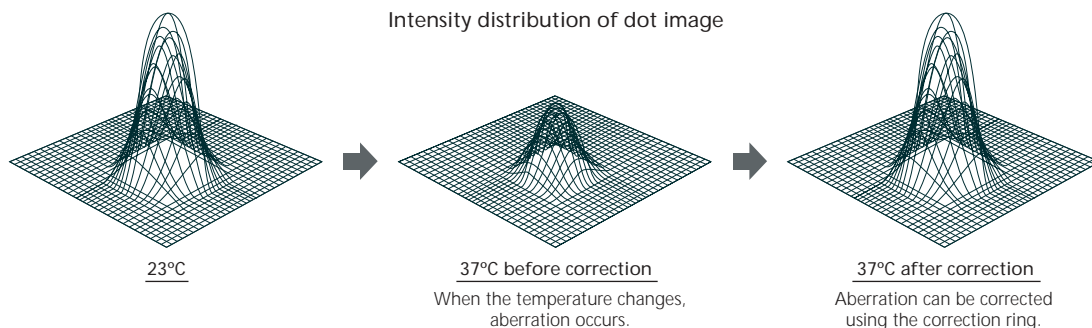

Multiport design

Multiport design broadens the range of observation and measurement

The TE2000-E has 5 ports. The TE2000-U has 4 ports. The TE2000-S has 2 ports. These ports distribute light in the ratios given below. TE2000 can shoot or measure with multiple cameras.

Main body	Port select address				
	1	2	3	4	5
TE2000-E	Eye 100%	Front 80% Eye 20%	Bottom 100%* ¹	Right 80% Eye 20%	Left 100%
TE2000-U	Eye 100%	Front 80% Eye 20%	(Optional) * ²	Right 80% Eye 20%	Left 100%
TE2000-S	Eye 100%	Left 80% Eye 20%* ³	–	–	–

By changing the optional prism, the light distribution ratio of the shaded portions can be changed as below.

*1 Right: 100 Front: 100 Left: 80 (Eye: 20)

*2 Right: 100 Front: 100 Left: 80 (Eye: 20)

*3 Left: 100

The following portions can also be changed by altering the microscope body.

(Optional at the time of purchase)

*2 Bottom: 100

*3 Right: 100



Intermediate magnification module 1x-1.5x

Magnifications of all ports of the TE2000-E and TE2000-U, including the observation port, can be easily changed without the troublesome adjustment accompanying the change of objectives.



Enhanced overall rigidity

Sturdy design and thermal stability improve precision, minimize focus deviations

Stability for greater precision

To achieve stability that supports focusing precision, Nikon implemented Computer Assisted Engineering (CAE) and adopted a new high-strength alloy material in the microscope body. This doubled the rigidity compared with previous models.

Improved thermal stability

To minimize focus deviation due to temperature change, Nikon has reinforced the thermal stability of the microscope body, thus improving image quality during long hours of observation or photography.



Glass stage ring

This glass stage ring ensures minimum deformation caused by temperature change, minimizing blurred focus; so it is suitable for time lapse imaging.

Design innovations ensure hours of comfortable, strain-free use

Nikon has instituted numerous innovations to provide comfortable operation and reduce strain, even over a prolonged period of operation.



Main controls are concentrated in the front, close to the operator.

Knobs and buttons

Frequently used buttons and controls are all located at the front and within easy reach.

Fine focusing unit

The TE2000-E comes with a compact external fine focusing unit that can be placed anywhere on the desktop.



External fine focusing unit



Nosepiece is inclined to the left for easy handling.

Nosepiece

The nosepiece is inclined to the left, making it easy to read the magnification and adjust the correction ring.

Stage height

The low-profile stage facilitates handling of specimens.

Eyepiece tube

The 25° -inclination eyepiece tube minimizes fatigue during long hours of observation, while its Y-shaped design permits easy viewing of the specimen area on the stage.



Ergonomic tube

Ergonomic tube

An ergonomic tilting eyepiece tube is optionally available. Furnished with a built-in Bertrand lens, the inclination angle is adjustable from 15° to 45° for viewing in a relaxed and comfortable posture.



Eye-level riser (as indicated by arrow)

Eye-level riser

Optimal eyepiece height can be achieved by using optional eye-level risers. Each riser has a thickness of 25mm and up to two risers can be installed at a time. (The eye-level riser cannot be used with a stage riser)

Large stage-handle knob

Attaching the optional large stage-handle knob enables precise operation for the fine movement of the stage during high magnification observations.



Large stage-handle knob

Retrofittable motorized options

Motorized operation with greater precision and operability facilitates top-notch research

All three models accept retrofittable motorized accessories in their major sections, allowing researchers to not only choose the desired combinations, but also to control the microscope from external PCs.

Flexible motorized operation for a variety of uses

- A wide variety of motorized accessories are available and can be controlled by an external computer when a HUB controller is attached.
- Motorized switching of objectives and observation methods between epi-fluorescence, Nomarski DIC, phase contrast, Hoffman Modulation Contrast is possible*.

*There are some restrictions depending on the combination of model and observation method.

Communication HUB controller



The HUB controller manages all the cables of each motorized unit at the back of the microscope. By connecting to the RS-232C interface of a PC, motorized units can be controlled from the PC.

Motorized system condenser turret



This motorized turret for system condensers enables easier switching between brightfield, phase contrast, Nomarski DIC, and Hoffman modulation contrast observations.

Motorized sextuple DIC nosepiece



This nosepiece can be used for all observations including DIC. When changing the magnifications, the nosepiece automatically descends for easy, safe rotation of the objectives and then returns to the original height after rotation.

Motorized epi-fl filter rotating turret



A maximum of 6 epi-fl filter cubes can be mounted and easily changed with a remote control unit, even in dark rooms.



Epi-fl attachment with motorized shutter



This epi-fluorescence attachment has a built-in motorized illumination shutter.

Motorized barrier filter wheel



This motorized barrier filter wheel with a turret rotary system can mount up to 8 \varnothing 25mm barrier filters.

Motorized excitation filter wheel



This motorized excitation filter wheel with a turret rotary system can mount up to 8 \varnothing 25mm excitation filters.

Motorized analyzer



This motorized analyzer is used to remove and insert an analyzer for Nomarski DIC.

Remote control unit

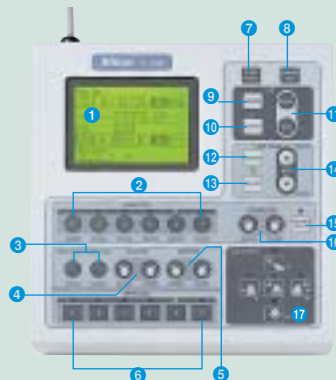

All motorized units attached to the microscope can be operated from this control pad with an LCD screen. Filter position labels glow in the dark for easy identification.

1. LCD Display
2. Objectives Changeover
3. Shutter Open/Close
4. Excitation Filter Changeover
5. Barrier Filter Changeover
6. Fluorescence Filter Block Changeover
7. Z-axis Reset
8. External Signal Output
9. LCD Operation Mode Changeover
10. LCD Backlight On/Off
11. LCD Brightness Control
12. Diascopic Lamp Control by Remote Pad
13. Diascopic Lamp On/Off
14. Diascopic Lamp Brightness Control
15. Condenser Cassette Changeover
16. Analyzer In/Out
17. Light Path Changing Prism Changeover

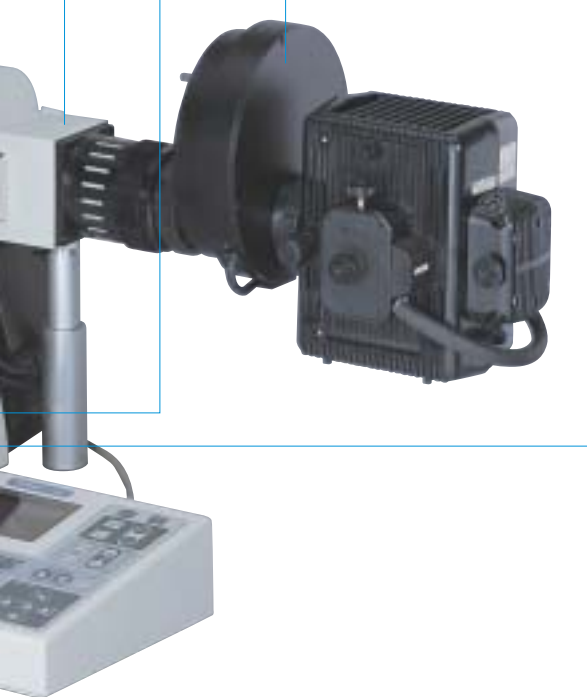

Motorized model **ECLIPSE TE2000-E**

The TE2000-E comes standard with motorized-focus and motorized 5-way light port changeover—perfect for advanced research that requires high resolution image capture in 3D, including confocal microscopy and deconvolution processing.



TE2000-E configured with C1 confocal system

Can be operated from a PC

It is possible to operate the microscope from a PC using third-party application software.

Greater Z-axis precision

The E model features a minimum Z-axis linear encoded readout of $0.05\mu\text{m}$ when operated from the connected PC. It enables perfect accuracy focus repeatability.



Objective anti-collision mechanism

When changing the objective magnification, the nosepiece automatically descends and returns to the original height, preventing the objective from hitting the stage. This anti-collision design is particularly handy when observing the development of a live specimen being cultivated in a chamber.



Coarse focus switches

Motorized descending/return of the nosepiece is also possible with Escape/Refocus switches. It is particularly useful for changing specimens when using oil-immersion objectives.

Auto switching between 5 ports

The E model has five output ports, including a bottom port, which can be easily switched via motorized control.

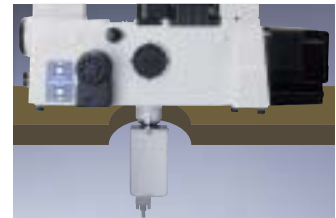

External fine focusing unit

By attaching this compact external fine focusing unit, fine focusing can be easily controlled anywhere on the desktop. It can be used vertically or horizontally.



Remote control unit

From the remote control unit, all motorized units can be operated easily in a darkroom thanks to the phosphorescent display tags.



Epi-fluorescence

Flawless, high-contrast fluorescence images

Thanks to a noise terminator mechanism and zoom illumination, the TE2000 achieves an unparalleled S/N ratio and brightness. It performs well even for weak, single-molecular-level fluorescence observations at leading-edge research.

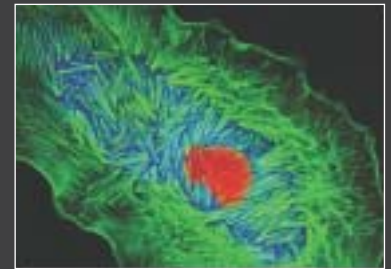
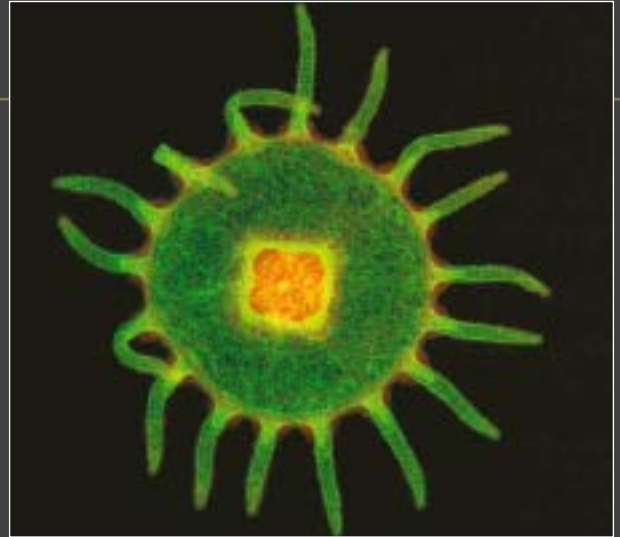

8.

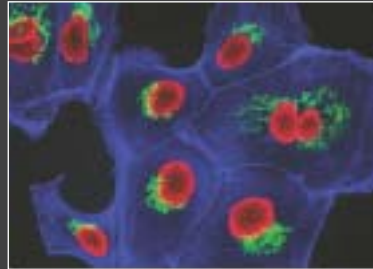

7.



The Noise Terminator mechanism directs deviated stray light out of the optical path. This results in images of high contrast and unparalleled S/N ratio.

High quality fluorescence filters

Filters and mirrors with a sharp rising edge successfully minimize signal crossover.



Zoom-type lamphouse adapter allows the operator to increase light intensity.



Remote control unit and filter turret use phosphorescent display tags to enhance visibility during operation in dark rooms.

Nomarski DIC

With the new DIC system, it is possible to obtain the best image appropriate to the needs

Uniform coloration

Excellent images with uniform coloration are now possible, at any magnifications, by changing the material composition of the DIC prisms.

The perfect balance of high contrast and high resolution

A combination of DIC modules and sliders can be selected from three types (high contrast, high resolution and standard type) to perfectly fit your observation needs and specimens. The standard type, in particular, is greatly balanced in contrast and resolution at any magnification.

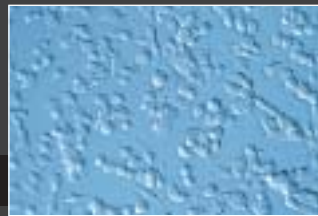

Using Rotating Senarmont Compensation method

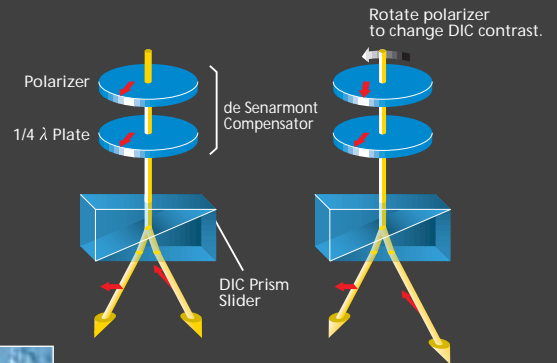

High resolution DIC

Observe ultra-minute structures at full optical performance

A high resolution DIC prism (Dry, Oil) has been made available especially for high magnification observations. By combining a high transmission polarizer and analyzer and a high magnification condenser, it is possible to configure a microscope system optimized for a high resolution video enhanced contrast DIC system.



Rat cell culture from lymph node



9. Sea urchin egg

Epi-fluorescence and Nomarski DIC

By combining epi-fluorescence and DIC it is easy to accurately locate fluorescent tagged structures or artifacts within a specimen.



10. Rat embryo in cell division (EGFP transgenic rat)



Phase contrast

Enables high-contrast imagery of minute living cells

Phase contrast is the most popular observation method for inverted microscopes. This method does not require the staining of the specimen, therefore you can observe and research precise structures of living cells without influencing the live organism.

New phase contrast—"Apodized" phase contrast

In addition to the conventional phase contrast objectives, Nikon developed the new Apodized phase contrast objectives to effectively reduce halos, which was considered troublesome with the conventional phase contrast method. The internal structures of cells ongoing cell division or thick phase objects used to submerge in halos, making observation difficult, but they are now visible with excellent contrast and a much wider tonal range. For research level work, we are proud to introduce CFI Plan Fluor ELWD ADL objectives, which excel in image flatness in addition to higher resolution and brightness.

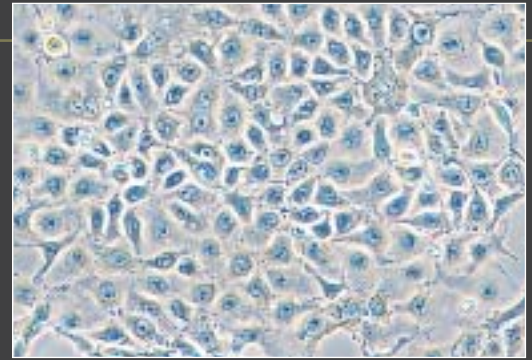

11. Monkey kidney cells
Viewed with the conventional phase contrast method

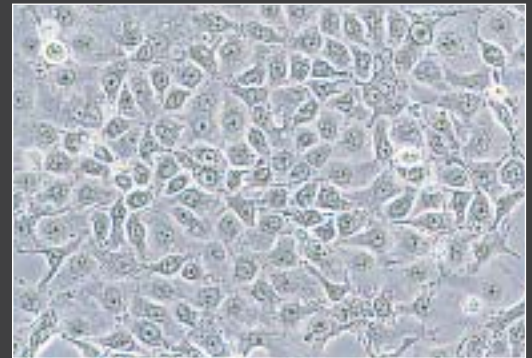

11. Monkey kidney cells
Viewed with the Apodized method



ADL objective series

Hoffman Modulation Contrast®

3D-like images made easy

This technique permits observation of living specimens using plastic petri dishes, which is not possible with DIC. The combination of dedicated HMC objectives and HMC condenser components creates high contrast 3D-like images of living transparent specimens without the halos seen under phase contrast.



12. Bovine ovum



Trichuris trichiura egg

Note: Hoffman Modulation Contrast and HMC are registered trademarks of Modulation Optics, Inc.

Laser TIRF system

High signal to noise (S/N) optimizes observation of single molecule activity in fluorescence observation

- A unification of a laser TIRF unit and epi-fluorescence illumination system. Switching the systems is elementary.
- Responds to various levels of research such as from epi-fluorescence observation of living organisms to observation of living cells at the molecular level.
- Captures single molecule activity in living cells with an extraordinary high S/N ratio where they contact the coverglass.
- The TE2000's unique "stratum structure" allows the simultaneous mounting of laser tweezers.



13. Fixed 3T3 fibroblasts

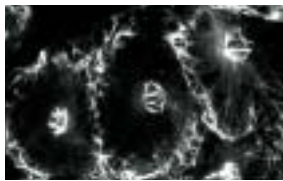
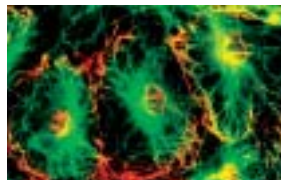

Image under TIRF observation



Image under epi-fluorescence observation



TIRF/epi-fluorescence image overlay (pseudo-color)

White light TIRF system

Easily realizes TIRF observation without using laser illumination

- A TIRF function has been provided with the epi-fluorescence attachment. TIRF observation using mercury illumination is available. Xenon and high-intensity halogen can also be used.
- Simply inserting an exclusive aperture (60X, 100X) enables switching to TIRF.
- The wide wavelength band of mercury illumination makes multiple wavelength observation possible by changing the filter. No worries for interference patterns.



Mercury TIRF image



Epi-fluorescence image

Digital Eclipse C1—modular confocal microscope system

Compact, high performance personal type confocal microscope system

- Small modular structure. Easy to upgrade.
- Supports any image capturing such as simultaneous 3-channel fluorescence, 3-channel plus DIC, time-lapse recording and spatial analysis.
- Filters are interchangeable to match fluorescent dyes, enabling researchers to use the latest probes or dyes available.
- Realizes ROI scanning using AOM (Acousto-Optic Modulator) and FRAP (Fluorescence Recovery After Photo Bleaching) time lapse recording.

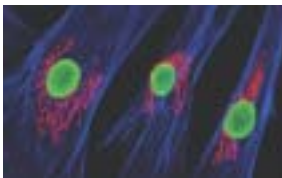

14.

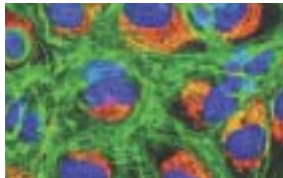

15.

Photic stimulation unit

Easily realizes photic stimulation without a confocal microscope system

- Compact and easy to attach, easy to operate.
- Observation of molecule movement by photic stimulation in a cell is possible, using fluorescence protein such as Kaede (photo conversion) and PA-GFP (photo activation).
- Achieves short wavelength correction up to 405nm (h-line). Combined with VC series objectives, in which aberration is corrected to 405nm, it illuminates the targeted area with high precision.



Time-lapse images after stimulation can be recorded in series.

Digital Sight-series digital cameras

Great freedom of choice

Two types of camera heads and two types of control units are available. Select the combination best suited to your purpose.

- DS-5Mc-U1 (PC-control cooled color camera)
- DS-5Mc-L1 (standalone-type cooled color camera)
- DS-5M-U1 (PC-control standard color camera)
- DS-5M-L1 (standalone-type standard color camera)



DS-5Mc-U1 configuration

DS-5Mc



Cooled color camera head: DS-5Mc

Incorporating a cooling mechanism in the 5-megapixel CCD to maintain the CCD at 20°C below room temperature, this camera delivers high-contrast images with low background noise generated by heat, even of weakly fluorescing and darkfield specimens.

DS-5M



Standard color camera head: DS-5M

Researchers can easily capture high-definition digital images at a resolution of 5 megapixels (2,560 x 1,920 effective pixels).

DS-U1



PC-use control unit: DS-U1

Using this unit, researchers can easily connect a camera with a PC via a USB2.0 interface. Camera control software ACT-2U facilitates image capture and analysis with simple operational steps. A high-speed 15fps data transfer facilitates strain-free focusing with live images.

DS-L1



Standalone control unit: DS-L1

The DS-L1 is equipped with a high-definition 6.3-inch LCD monitor, allowing you to capture images easily without the need for a PC. Researchers can easily perform imaging sessions by selecting the optimum setting from a "Scene mode" menu. The DS-L1 also features a networking function to store images directly on a network-wide basis.

Two types of camera head and two types of control unit allow you to select the combination to suit your needs.

DS-5Mc-U1
(PC-control cooled color camera)

For advanced research that analyzes faint epi-fluorescence images with a PC.



Cooled Camera Head
DS-5Mc



PC-use Control Unit
DS-U1

DS-5Mc-L1
(standalone-type cooled color camera)

Easily captures high S/N ratio epi-fluorescence images without a PC. Sharing images over a network is also possible.

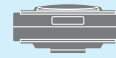

Cooled Camera Head
DS-5Mc



Standalone Control Unit
DS-L1

DS-5M-U1
(PC-control standard color camera)

Brightfield, phase contrast, and DIC images can be transferred at high speed to a PC.



Standard Camera Head
DS-5M



PC-use Control Unit
DS-U1

DS-5M-L1
(standalone-type standard color camera)

Under brightfield, phase contrast, and DIC methods, "Scene mode" enables optimum image capture.



Standard Camera Head
DS-5M



Standalone Control Unit
DS-L1

DXM1200F digital camera

The DXM1200F delivers superb high-quality images composed of up to approximately 12 million output pixels while providing sensitivity more than double that of previous models. The camera's software aids the researcher to take a large number of images with ease.



NT-88NE micromanipulator system

A packaged set of instrumentation required for cellular micromanipulation, the NT-88NE is ideal for IVF (in-vitro fertilization), ICSI (intracytoplasmic sperm injection), electrophysiology, or biotechnology applications.



Stage incubation system INU-NI-F1

This all-in-one compact CO₂ incubator sustains the internal temperature at 37°C with humidity of 90% and CO₂ of 5% to keep the specimen in a stable and precise condition. A special technique that minimizes focus blur facilitates long hours of time-lapse imaging.



Incubator

With an acrylic plastic enclosure providing easy access to the specimen area, this accessory utilizes warm air circulation and maintains the temperature of the interior at 37°C. The temperature is also adjustable from room temperature to 40°C.



Thermal plate warmer

A temperature controllable stage ring with a glass heating plate keeps the specimen at a set temperature. Temperature is adjustable from room temperature to 50°C in 0.1°C increments.



Specifications



	TE2000-E	TE2000-U	TE2000-S
Main body			
Optical system	CFI60 infinity optical system, parfocal distance 60mm		
Light distribution	5 positions, motorized light-distribution changer Observation 100, Left port 100, Right port 80, Front port 80, Bottom port 100 * 3 other models are available as options: 1) left 80/100 switchable instead of bottom 100 2) right 80/100 switchable instead of bottom 100 3) front 80/100 switchable instead of bottom 100	4 positions Observation 100, Left port 100, Right port 80, Front port 80 * 4 other models are available as options for 5-position light distribution: 1) with bottom port (must be added, 100% light) 2) left 80/100 switchable 3) right 80/100 switchable 4) front 80/100 switchable	2 positions Observation 100, Left port 80 * 2 other models are available as options: 1) left 100 instead of 80 2) right port (must be added) 100 instead of left 80
Focusing	Via motorized/manual nosepiece up/down movement Stroke—manual: up 7mm, down 3mm; motorized: up 6mm, down 2.5mm Coarse stroke: 4.9mm/rotation; Fine stroke: 0.1mm/rotation (motorized) Minimum fine reading: 0.05 μ m by optical linear encoder External fine focusing unit	Via nosepiece up/down movement Stroke—manual: up 7mm, down 3mm Coarse stroke: 4.9mm/rotation; Fine stroke: 0.1mm/rotation Minimum fine reading: 1 μ m Refocusing stopper: Adjustable coarse torque stopper	Via nosepiece up/down movement Stroke—manual: up 7mm, down 3mm Coarse stroke: 4.9mm/rotation; Fine stroke: 0.1mm/rotation Minimum fine reading: 1 μ m Adjustable coarse torque stopper
Intermediate magnification	1.5X	1.5X	—
Extendible structure	Available		
Other	Light intensity control; Light on/off switch		
Eyepiece tube	(1) T-TD Binocular Tube D (2) T-TS Binocular Tube S (3) T-TERG Binocular Ergonomic Tube D (4) T-TI Intermediate Tube for Eclipse E600/400 trinocular tubes and teaching heads		
Eyepiece lens (F.O.V.)	CFI 10X (22mm), CFI 12.5X (16mm), CFI 15X (14.5mm)		
Illumination	(1) T-DH 100W Illumination Pillar (2) T-DS 30W Illumination Pillar		
Condenser	SLWD condenser for phase contrast*, ELWD condenser for phase contrast*, System condenser LWD**, ELWD** Motorized system condenser LWD**, ELWD**, Hoffman Modulation condenser® (HMC), High N.A. condensers *Only for 30W pillar **Only for 100W pillar		
Nosepiece	T-N6 Sextuple Nosepiece, T-ND6 Sextuple DIC Nosepiece, T-ND6-E Motorized Sextuple DIC Nosepiece		
Objectives	CFI60 objectives		
Stage	(1) T-SR Rectangular Stage—Cross travel: 70 x 50mm; Size: 300 x 276mm (2) T-SP Plain Stage—Size: 300 x 210mm; Mechanical stage mountable (3) T-SAM Attachable Mechanical Stage (must be used with T-SP Plain Stage)—Cross travel: 126 x 84mm; Specimen holders attachable		
Motorized functions	Fine focusing (minimum reading: 0.05 μ m), Objective anti-collision mechanism (when the nosepiece is rotated), Light distribution changer (Motorized options): DIC nosepiece, Analyzer, Epi-fl filter rotating turret, Epi-fl shutter, Excitation filter wheel, Barrier filter wheel, System condenser turret	—	—
Epi-fluorescence attachment	Six fluorescence filter blocks in rotating turret with shutter, Noise Terminator mechanism incorporated, Aperture diaphragm centerable, Field diaphragm centerable, 33mm ND4/ND8 filters, 25mm heat absorbing filter, Lamphouse adapter, Zoom lamphouse adapter (option)		
Nomarski DIC system	Contrast control: Senarmont method (by rotating polarizer) Objective side prism: for individual objectives (installed in nosepiece) Condenser side prism: LWD N1/N2, HNA N2/NR types *Nomarski DIC system can be attached only to 100W pillar.		
Optional accessories	Nikon Digital SLR D1, Digital Camera DXM1200F, Digital Camera DS-5M/5Mc-L1/U1, Photomicrographic Equipment FX-III series, Teaching Head, Drawing Tube, CCTV Adapters, Micromanipulators, etc.		
Power consumption (max.)	(TE2-PS 100W Power Supply) 100-230V, 2.4A/160W (TE-PS 30W Power Supply) 100/120V, 0.6A/80W; 230V, 0.4A/80W		
Weight (approx.)	Phase contrast set: 40kg; Epi-fl set: 45kg (w/100W pillar)	Phase contrast set: 36kg; Epi-fl set: 41kg (w/100W pillar)	Phase contrast set: 32kg (w/30W pillar)

System diagram

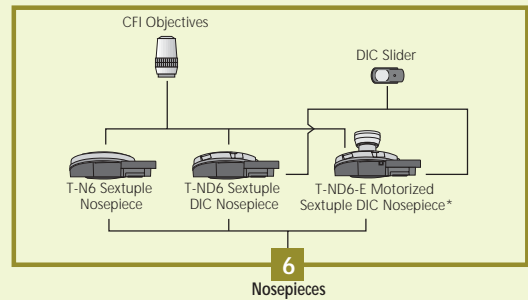
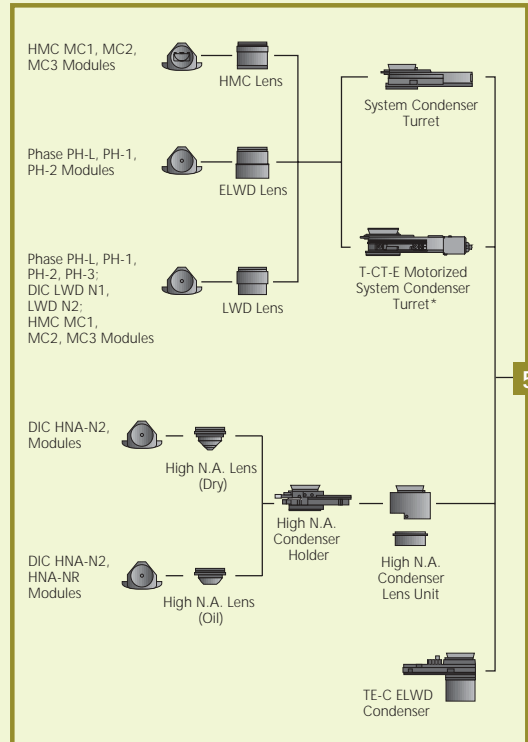
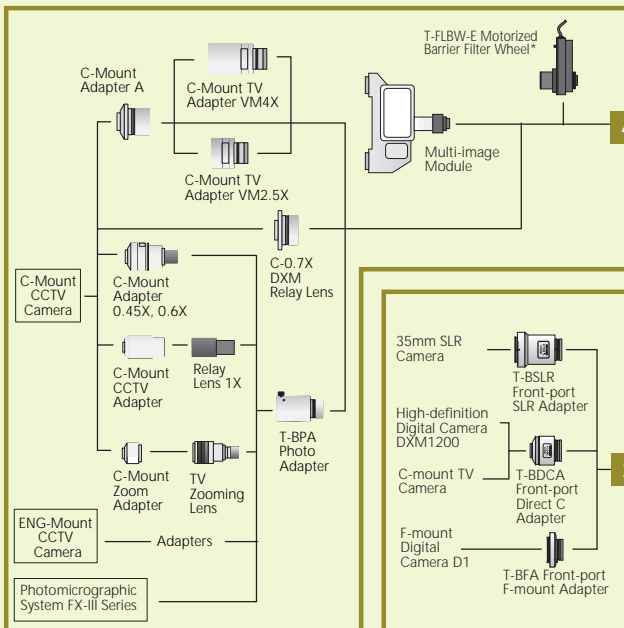
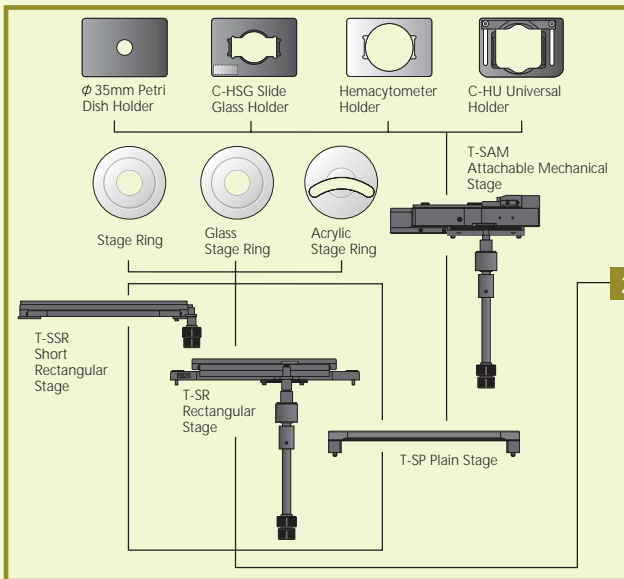
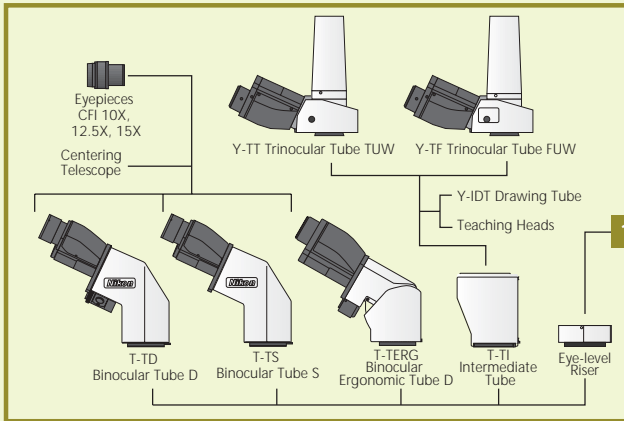

TE2000-E

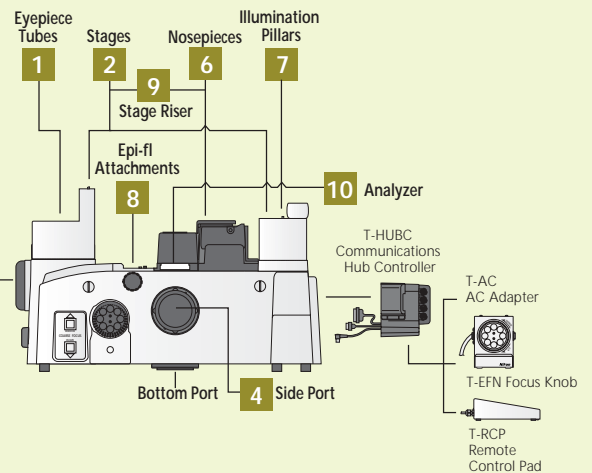

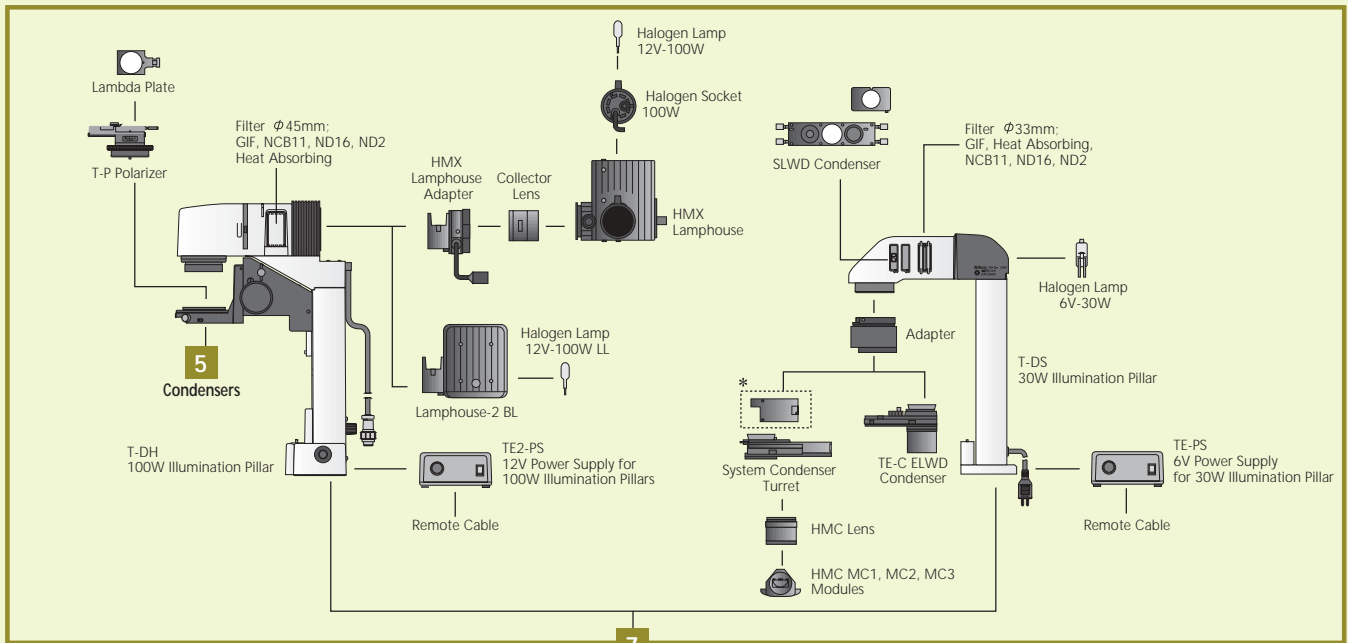

7 Illumination Pillars

* Provided with the HMC lens.

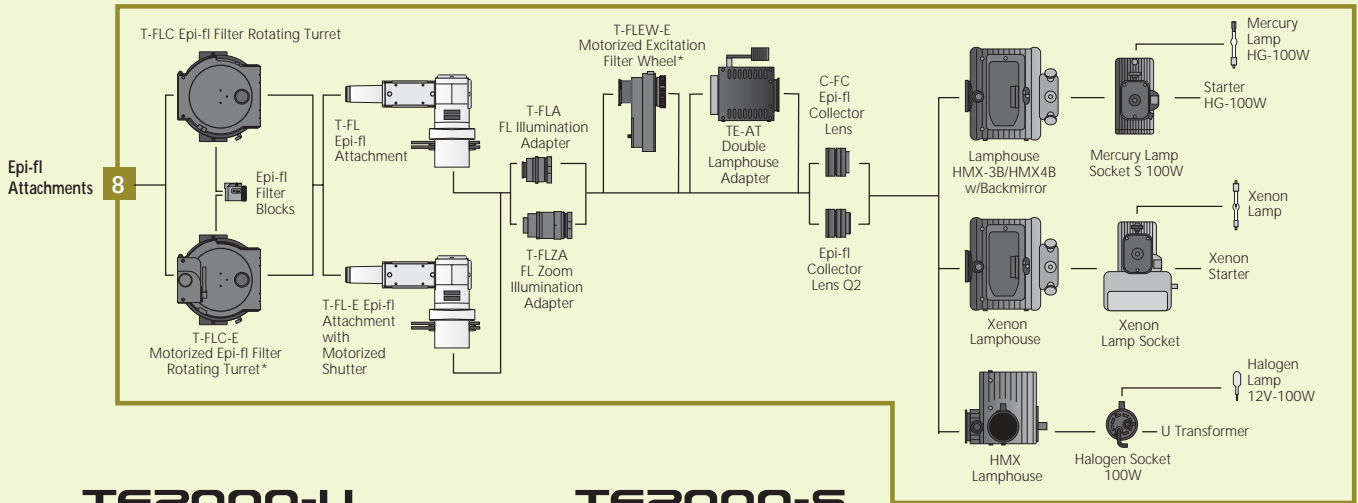

8 Epi-fl Attachments

TE2000-U

TE2000-S

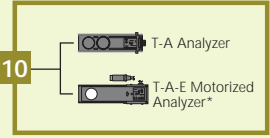
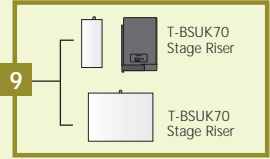
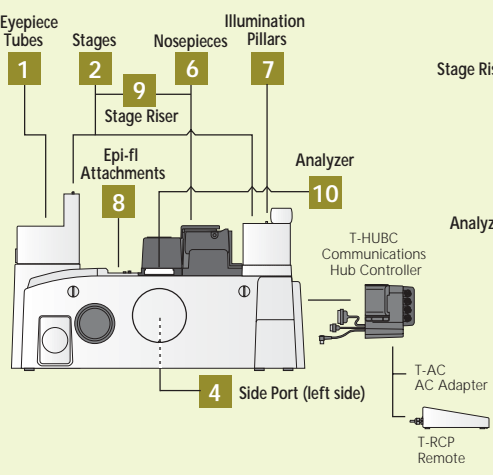
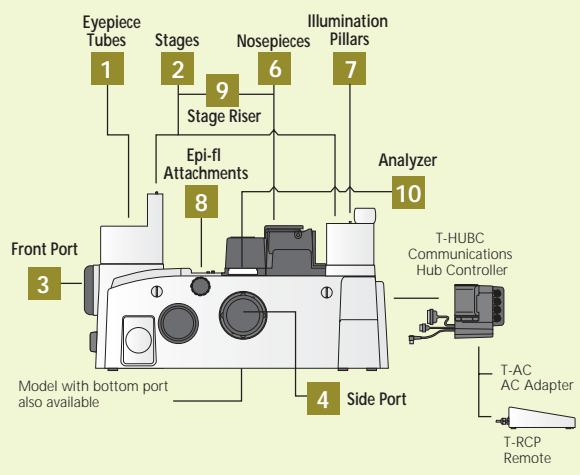

* Requires a communications hub controller.

Dimensional diagram

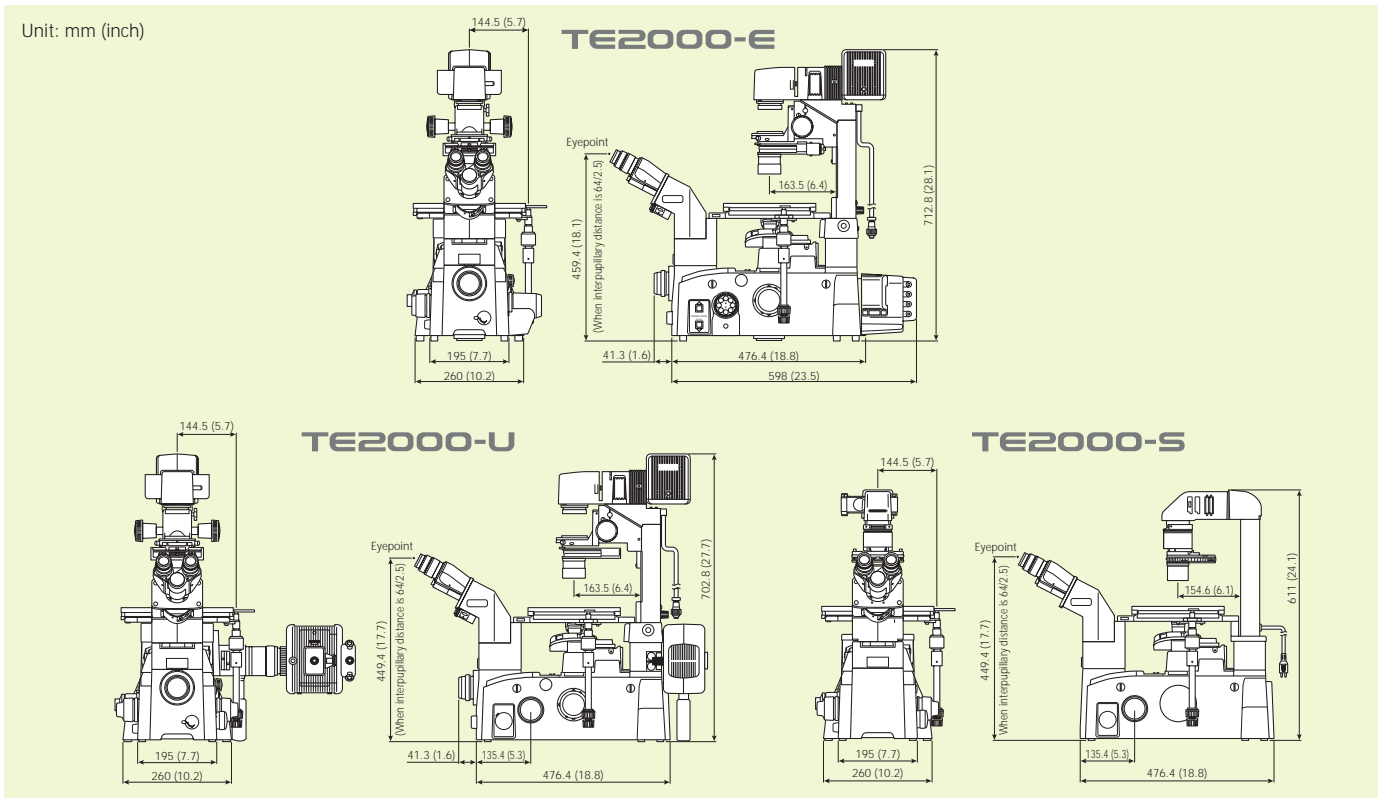

Photos courtesy of

- 1 David Froiland Bsc., Deidre Zander Bsc. Hons., Michelle Lane PhD., Research centre for Reproductive Health, University of Adelaide, Australia
- 2 Dylan Burnette, Paul Forscher Laboratory, Yale University, USA
- 3, 4, 5, 7, 8, 14, 15 Michael W. Davidson, National High Magnetic Field Laboratory, USA
- 6 Alexey Khodjakov, PhD. Wadsworth Center, NY Dept. of Health, USA

- 9 Yukihsa Hamaguchi, PhD, Tokyo Institute of Technology, Japan
- 10 Masumi Hirabayashi, PhD, YS New Technology Inst. Inc., Japan
- 11 Satoko Takaoka, Utsunomiya East Hospital, Japan
- 12 YS New Technology Inst. Inc., Japan
- 13 Dr. Gregg G. Gundersen, Columbia University, USA

Enter the "Microscopy University" on the web and discover a whole new world. www.microscopyu.com

Please contact Nikon for a handy pamphlet listing compatible accessories, including objectives and epi-fluorescence filters. Some models are not available in certain areas. Please check with your local Nikon representative for details.

Specifications and equipment are subject to change without any notice or obligation on the part of the manufacturer. December 2004. ©2004 NIKON CORPORATION

WARNING TO ENSURE CORRECT USAGE, READ THE CORRESPONDING MANUALS CAREFULLY BEFORE USING YOUR EQUIPMENT.

* Monitor images are simulated.
CompactFlash is a trademark of SanDisk Corporation, Sunnyvale, CA, U.S.A. Company names and product names appearing in this brochure are their registered trademarks or trademarks.

Certified ISO 14001 by **BVQI** U.K.A.S. ENVIRONMENTAL MANAGEMENT 008
ISO 14001 Certified NIKON INSTRCH CO., LTD.

Certified ISO 9001 by **BVQI** MGMT. SYS. RVA C 479
ISO 9001 Certified NIKON CORPORATION Instruments Company

BVQI NATIONAL ACCREDITATION OF CERTIFICATION BODIES
ISO 14001
ISO 14001 Certified NIKON CORPORATION Yokohama Plant

NIKON INSTRCH CO., LTD.
Parale Mitsui Bldg., 8, Higashida-cho, Kawasaki-ku, Kawasaki, Kanagawa 210-0005, Japan
phone: +81-44-223-2167 fax: +81-44-223-2182
www.nikon-instruments.jp/eng/

NIKON INSTRUMENTS (SHANGHAI) CO., LTD.
CHINA phone: +86-21-5058-5055 fax: +86-21-5058-5060 (Beijing office)
CHINA phone: +86-10-5869-2255 fax: +86-10-5869-2277

NIKON SINGAPORE PTE LTD
SINGAPORE phone: +65-6559-3618 fax: +65-6559-3668

NIKON MALAYSIA SDN. BHD.
MALAYSIA phone: +60-3-78763887 fax: +60-3-78763387

NIKON INSTRUMENTS EUROPE B.V.
P.O. Box 222, 1170 AE Badhoevedorp, The Netherlands
phone: +31-20-44-96-222 fax: +31-20-44-96-298
www.nikon-instruments.com/

NIKON FRANCE S.A.S.
FRANCE phone: +33-1-45-16-45-16 fax: +33-1-45-16-00-33
NIKON GMBH
GERMANY phone: +49-211-9414-0 fax: +49-211-9414-322

NIKON INSTRUMENTS S.p.A.
ITALY phone: +39-55-3009601 fax: +39-55-300993

NIKON AG
SWITZERLAND phone: +41-43-277-2860 fax: +41-43-277-2861

NIKON UK LTD.
UNITED KINGDOM phone: +44-20-8541-4440 fax: +44-20-8541-4584

NIKON INSTRUMENTS INC.
1300 Walt Whitman Road, Melville, N.Y. 11747-3064, U.S.A.
phone: +1-631-547-8500; +1-800-52-NIKON (within the U.S.A. only) fax: +1-631-547-0306
www.nikonusa.com/

NIKON CANADA INC.
CANADA phone: +1-905-625-9910 fax: +1-905-625-0103

NIKON CORPORATION
Fuji Bldg., 2-3, Marunouchi 3-chome, Chiyoda-ku, Tokyo 100-8331, Japan
www.nikon.com/

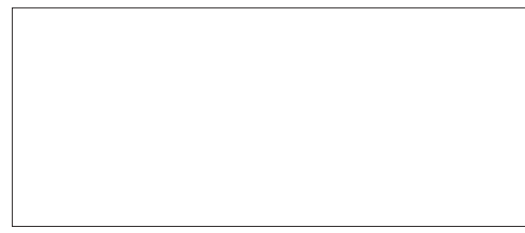

This brochure is printed on recycled paper made from 40% used material.